

1 PLANTA DE IMPLANTAÇÃO E COBERTURA 1
Esc.: 1/200

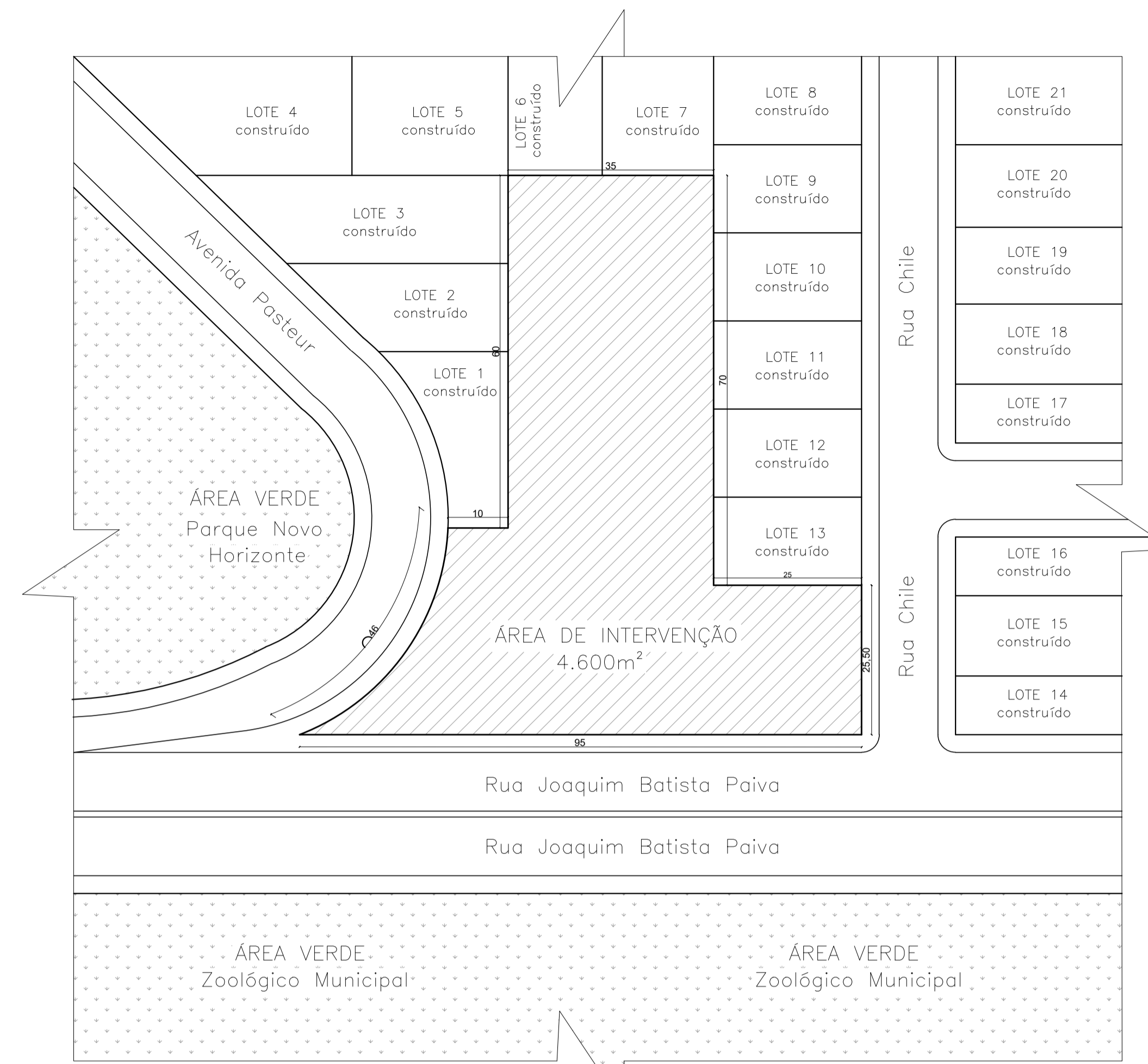

2 PLANTA DE SITUAÇÃO
Esc.: 1/700

TABELA DE ÁREAS

ÁREA TOTAL DO TERRENO	4.600m ²
ÁREA CONSTRUÍDA	3.002,70m ²
ÁREA PERMEÁVEL	1.505,30 m ²
TAXA DE OCUPAÇÃO	65,27%



Trabalho de Conclusão de Curso II
Arquitetura e Urbanismo – UNIS/MG
Aluna: Ana Luiza Venga Ferreira
Orientadora: Daniella Coli

PROJETO ARQUITETÔNICO CENTRO INTERGERACIONAL CONECTA GERAÇÕES NA CIDADE DE VARGINHA/MG

Conteúdo da Prancha:

Planta de Implantação e Cobertura 1
Planta de Situação

Escalas Indicadas
Data: 17/06/2019

01/08

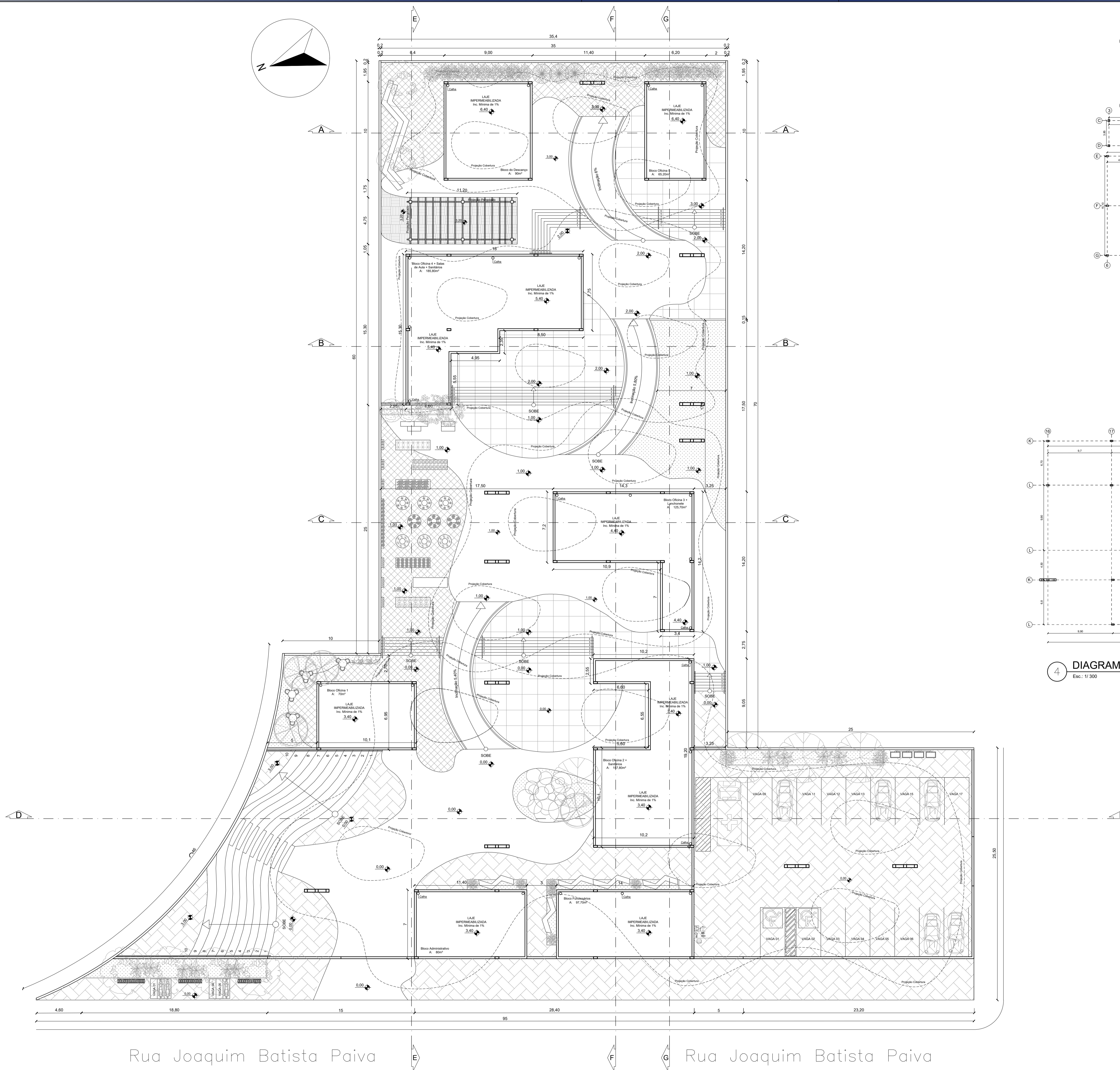

3 PLANTA DE COBERTURA 2
Esc.: 1/200

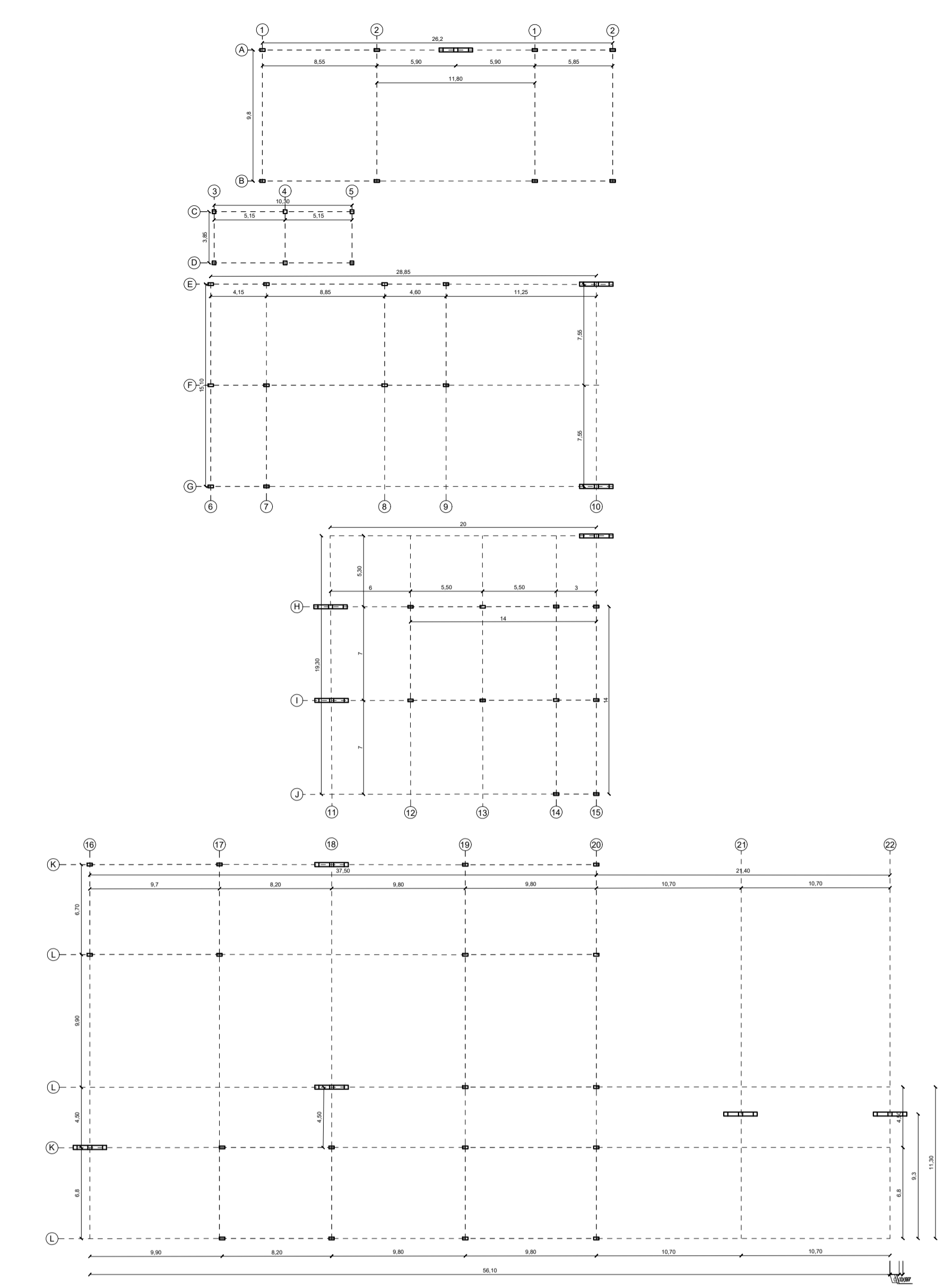

4 DIAGRAMA ESTRUTURAL
Esc.: 1/300

TABELA DE ÁREAS	
ÁREA TOTAL DO TERRENO	4.600m ²
ÁREA CONSTRUÍDA	3.002,70m ²
ÁREA PERMEÁVEL	1.505,30 m ²
TAXA DE OCUPAÇÃO	65,27%



Trabalho de Conclusão de Curso II
Arquitetura e Urbanismo – UNIS/MG
Aluna: Ana Luiza Venga Ferreira
Orientadora: Daniella Coli

PROJETO ARQUITETÔNICO
CENTRO INTERGERACIONAL
CONECTA GERAÇÕES NA CIDADE
DE VARGINHA/MG

Conteúdo da Prancha:
Planta de Cobertura 2
Diagrama Estrutural

Escalas Indicadas
Data: 17/06/2019

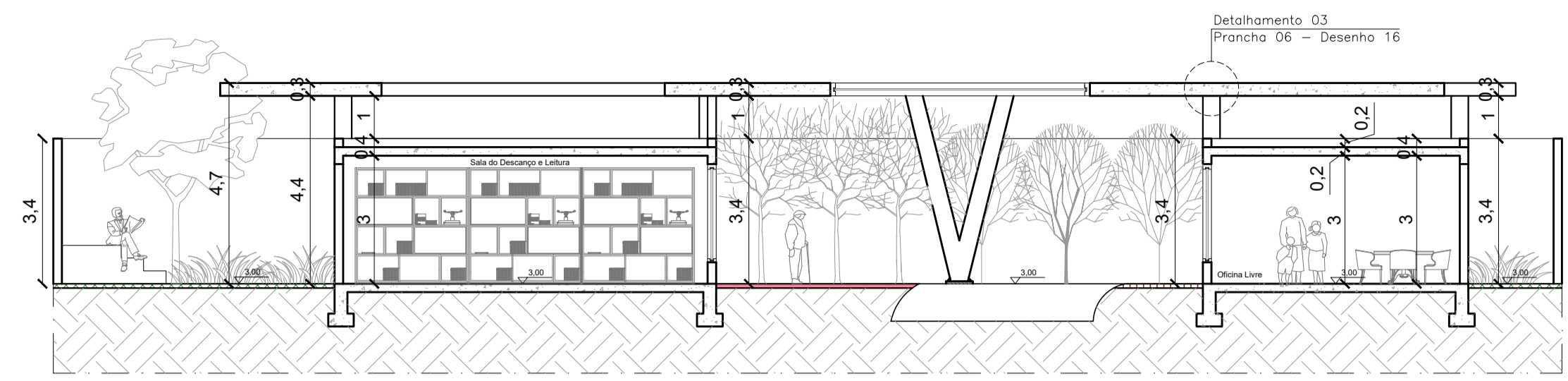
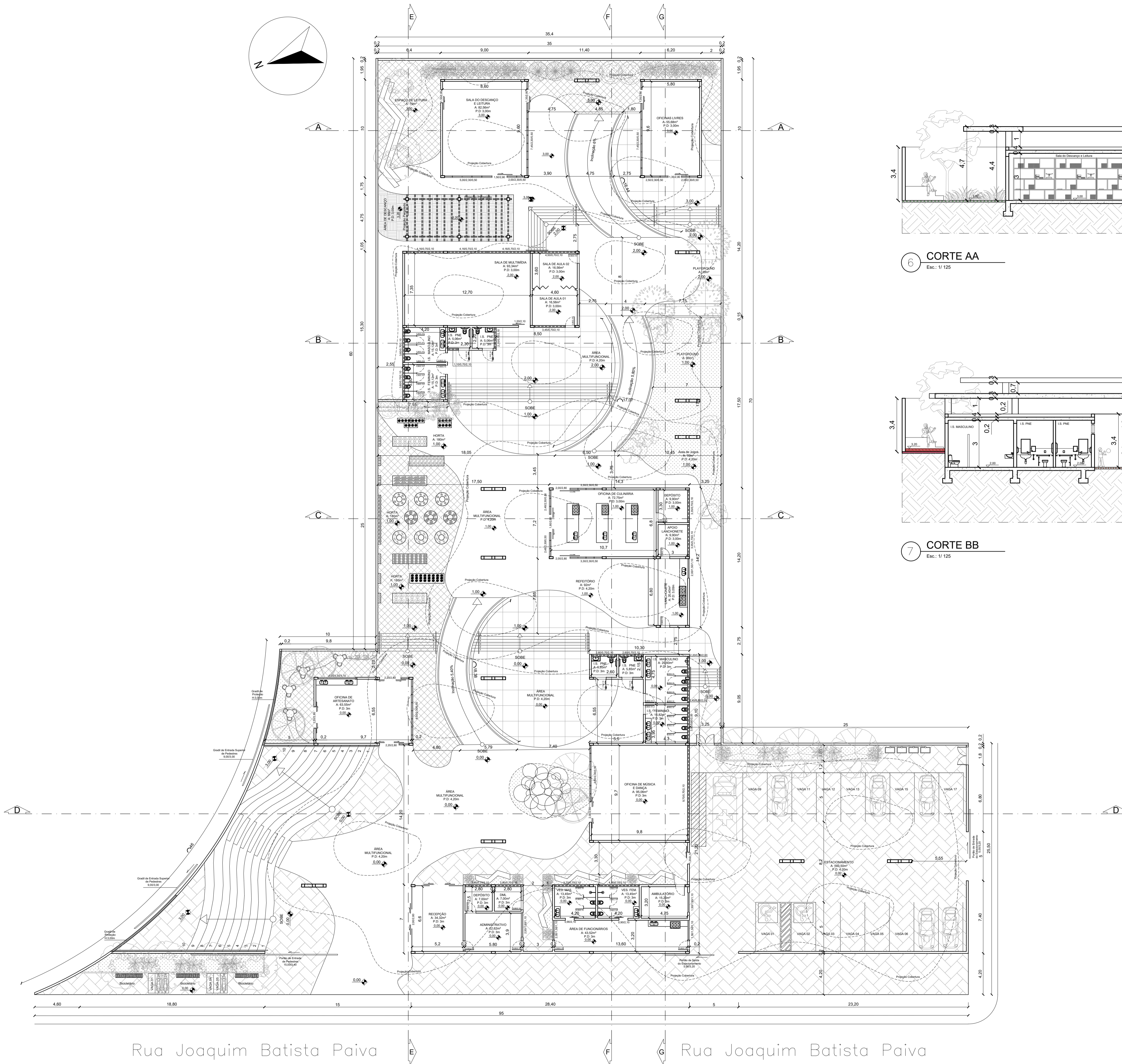
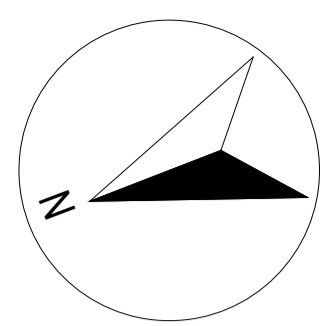

6 CORTE AA
Esc: 1/125

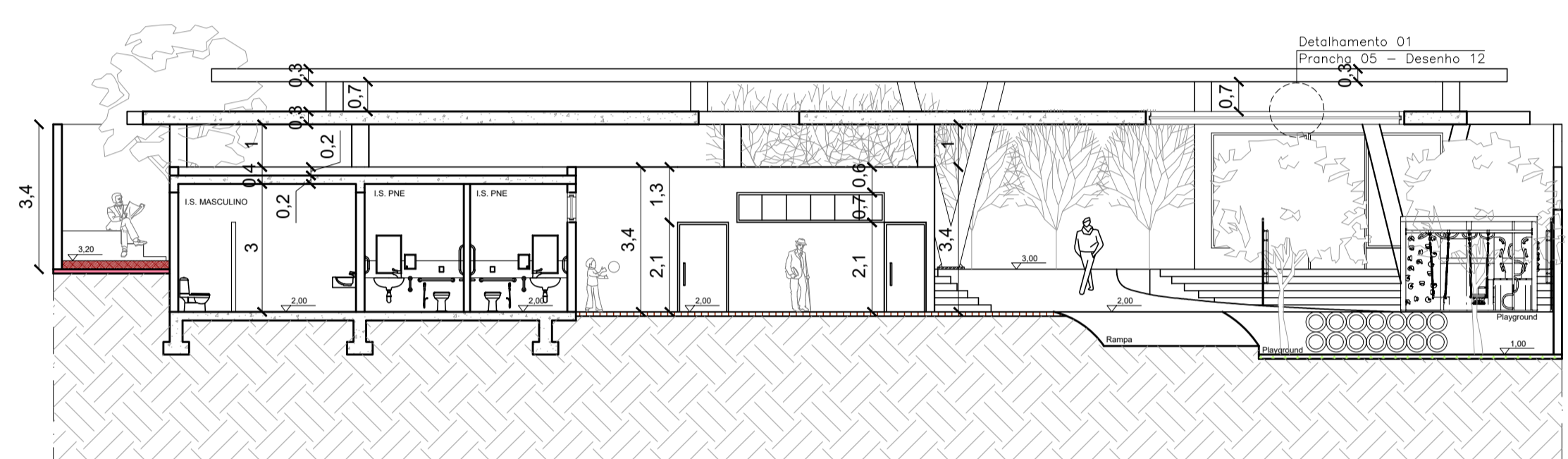

7 CORTE BB
Esc: 1/125

TABELA DE ÁREAS

ÁREA TOTAL DO TERRENO	4.600m ²
ÁREA CONSTRUÍDA	3.002,70m ²
ÁREA PERMEÁVEL	1.505,30 m ²
TAXA DE OCUPAÇÃO	65,27%



Trabalho de Conclusão de Curso II
Arquitetura e Urbanismo – UNIS/MG
Aluna: Ana Luiza Venga Ferreira
Orientadora: Daniella Coli

PROJETO ARQUITETÔNICO CENTRO INTERGERACIONAL CONECTA GERAÇÕES NA CIDADE DE VARGINHA/MG

Conteúdo da Prancha:
Planta Baixa
Corte AA
Corte BB

Escalas Indicadas
Data: 17/06/2019

03/08

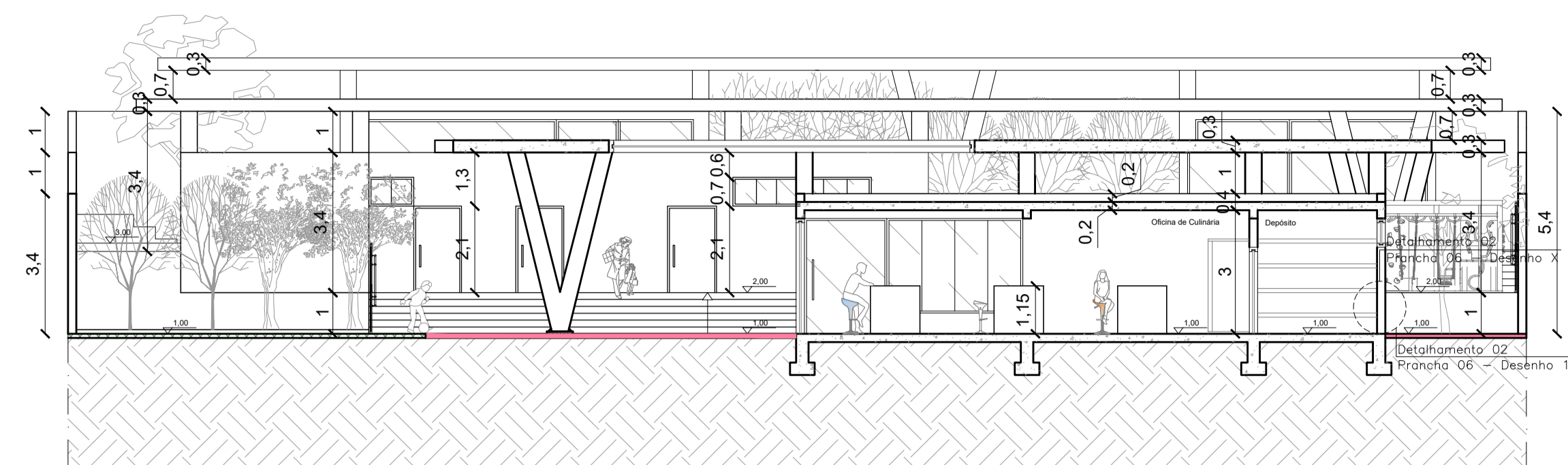
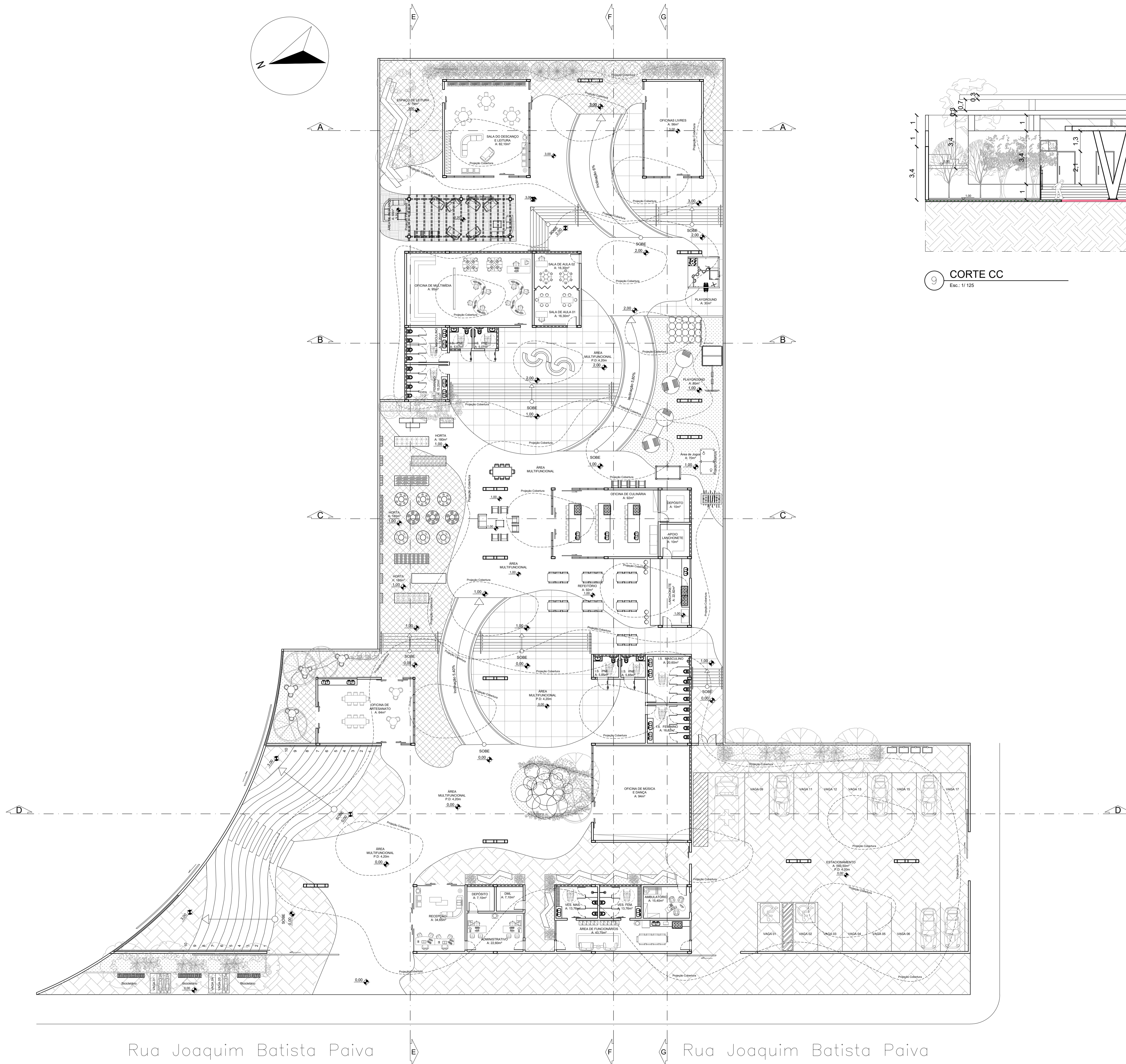
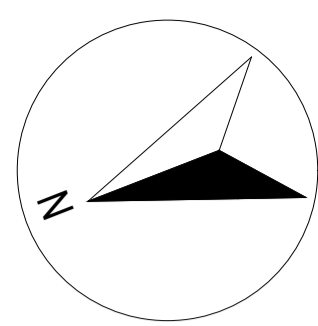

9 CORTE CC
Esc.: 1/125

TABELA DE ÁREAS

ÁREA TOTAL DO TERRENO	4.600m ²
ÁREA CONSTRUÍDA	3.002,70m ²
ÁREA PERMEÁVEL	1.505,30 m ²
TAXA DE OCUPAÇÃO	65,27%



Trabalho de Conclusão de Curso II
Arquitetura e Urbanismo – UNIS/MG
Aluna: Ana Luiza Venga Ferreira
Orientadora: Daniella Coli

PROJETO ARQUITETÔNICO CENTRO INTERGERACIONAL CONECTA GERAÇÕES NA CIDADE DE VARGINHA/MG

Conteúdo da Prancha:

Planta Humanizada
Corte CC

Escala Indicada
Data: 17/06/2019

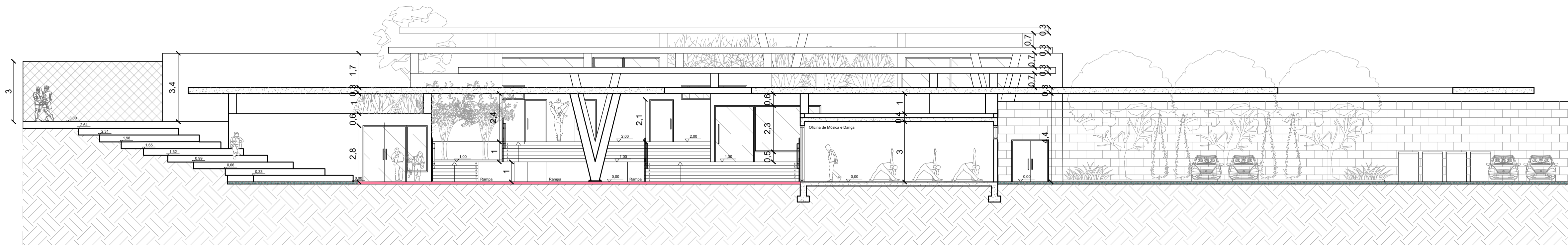

10 CORTE DD
Esc.: 1/125

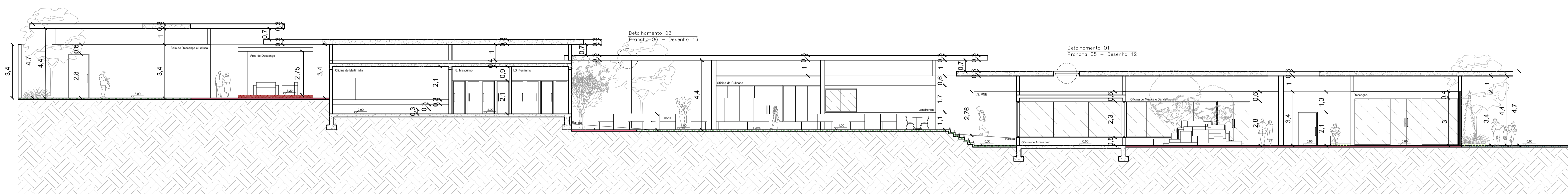

11 CORTE EE
Esc.: 1/125

Cobertura em Vidro Translúcido de Alto Desempenho

Proteção Térmica e Transparência

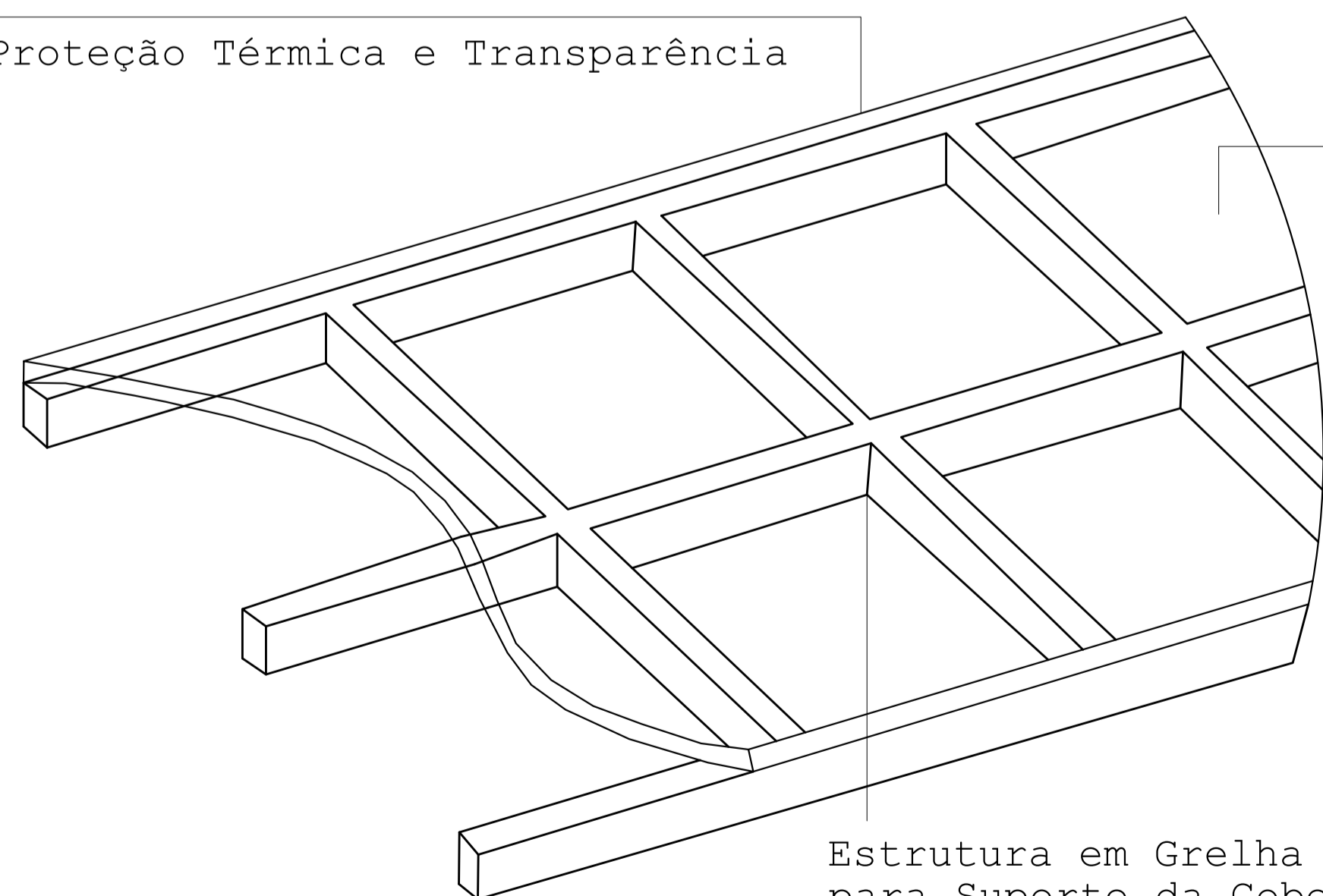

Estrutura em Grelha Metálica para Suporte da Cobertura em Vidro

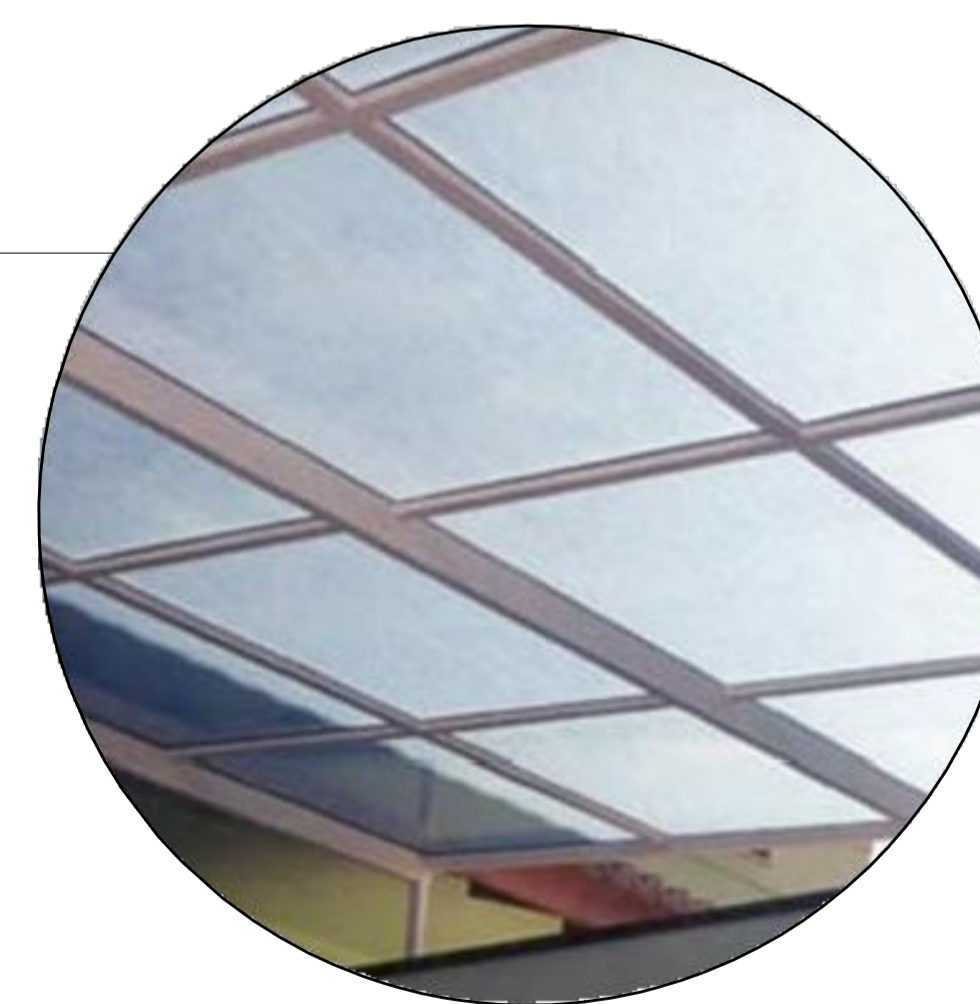

Cobertura – Vidro com Estrutura Metálica

12 DETALHAMENTO 01
Esc.: 1/20

TABELA DE ÁREAS

ÁREA TOTAL DO TERRENO	4.600m ²
ÁREA CONSTRUÍDA	3.002,70m ²
ÁREA PERMEÁVEL	1.505,30 m ²
TAXA DE OCUPAÇÃO	65,27%



Trabalho de Conclusão de Curso II
Arquitetura e Urbanismo – UNIS/MG
Aluna: Ana Luiza Venga Ferreira
Orientadora: Daniella Coli

PROJETO ARQUITETÔNICO
CENTRO INTERGERACIONAL
CONECTA GERAÇÕES NA CIDADE
DE VARGINHA/MG

Conteúdo da Prancha:
Corte DD
Corte EE
Detalhamento 01

Escalas Indicadas
Data: 17/06/2019

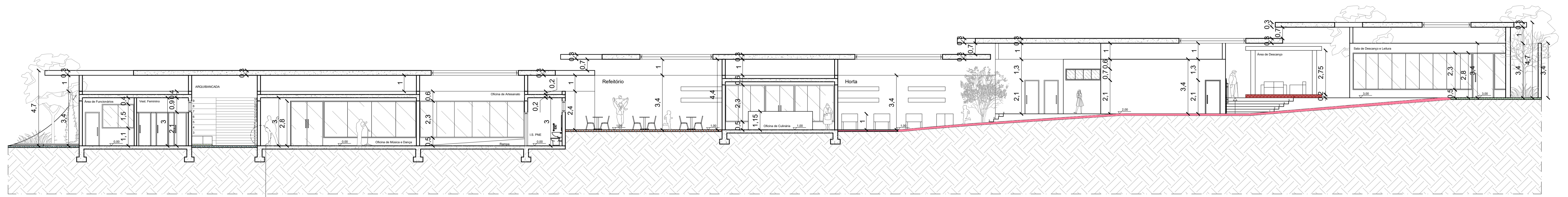

13 CORTE FF
Esc.: 1/125

Detalhamento 02
Prancha 06 - Desenho 15

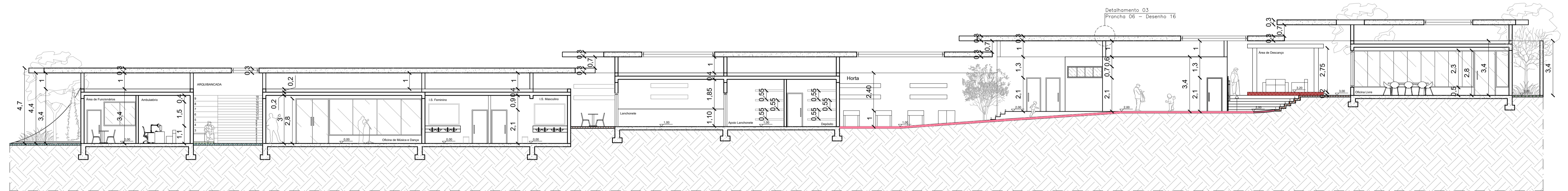

14 CORTE GG
Esc.: 1/125

Detalhamento 03
Prancha 06 - Desenho 16

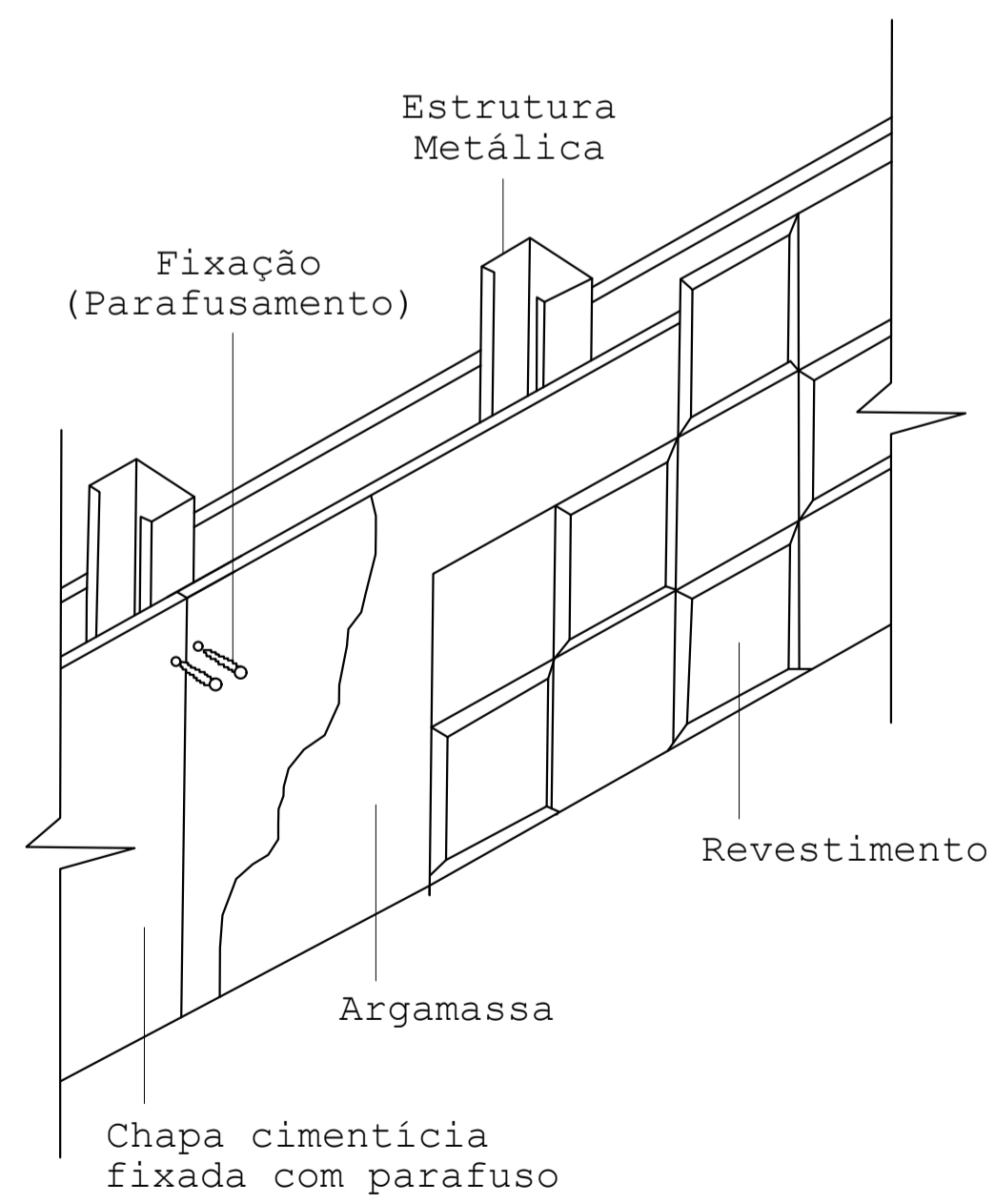

15 DETALHAMENTO 02
Esc.: 1/20

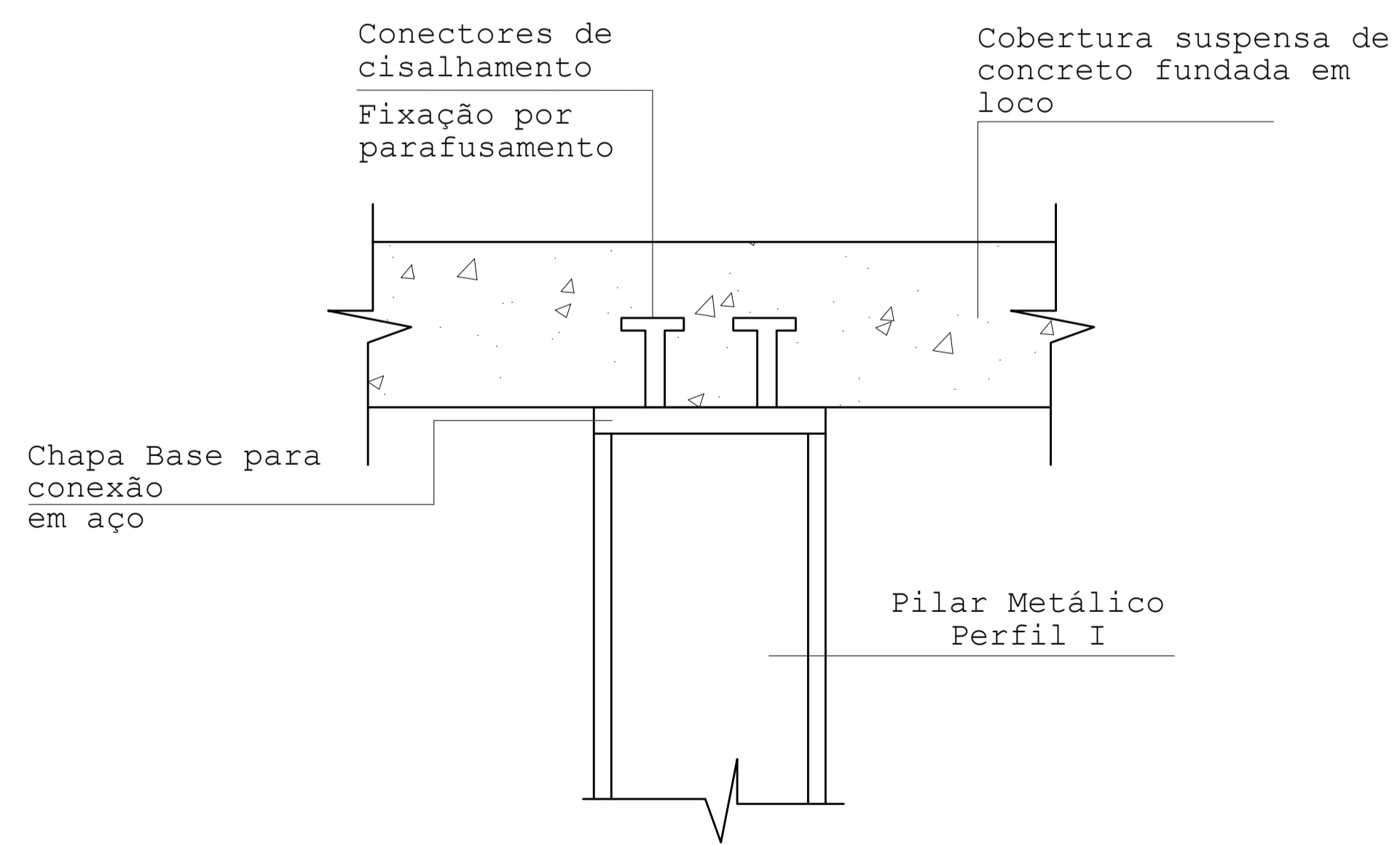

16 DETALHAMENTO 03
Esc.: 1/10

TABELA DE ÁREAS

ÁREA TOTAL DO TERRENO	4.600m ²
ÁREA CONSTRUÍDA	3.002,70m ²
ÁREA PERMEÁVEL	1.505,30 m ²
TAXA DE OCUPAÇÃO	65,27%



Trabalho de Conclusão de Curso II
Arquitetura e Urbanismo – UNIS/MG
Aluna: Ana Luiza Venga Ferreira
Orientadora: Daniella Coli

PROJETO ARQUITETÔNICO CENTRO INTERGERACIONAL CONECTA GERAÇÕES NA CIDADE DE VARGINHA/MG

Conteúdo da Prancha:
Corte FF
Corte GG
Detalhamento 02
Detalhamento 03
Escalas Indicadas
Data: 17/06/2019

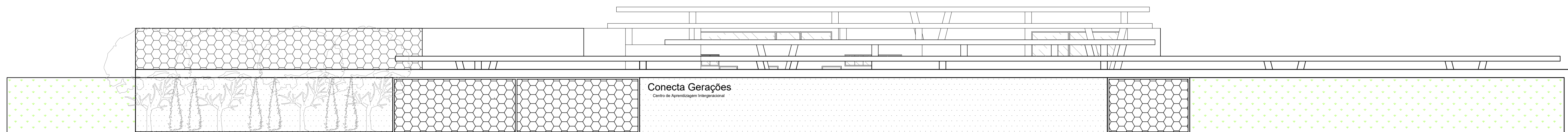

17 Fachada Frontal
Esc.: 1/125



18 Perspectiva 01

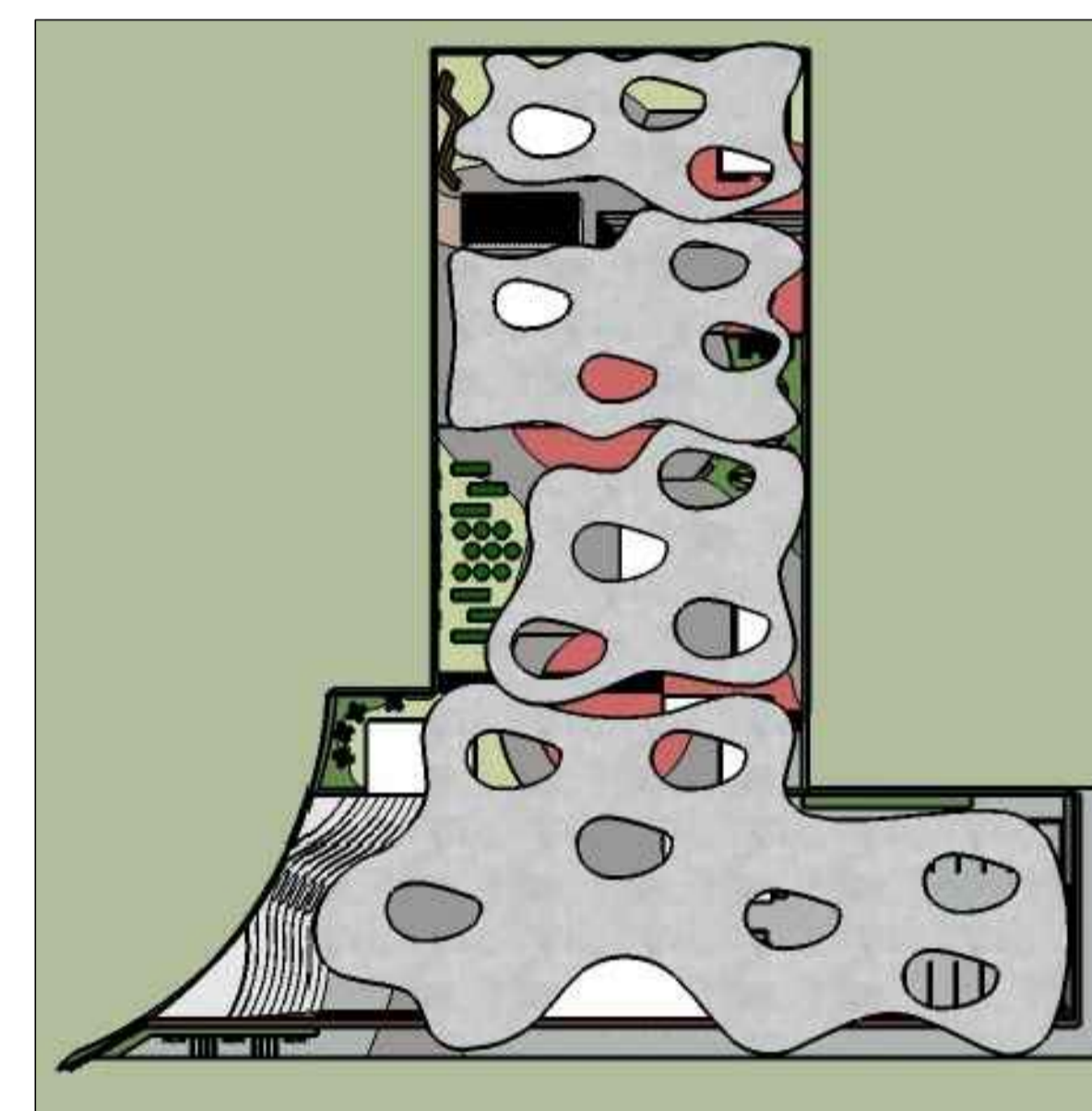

19 Perspectiva 02



20 Perspectiva 03



21 Perspectiva 04

TABELA DE ÁREAS

ÁREA TOTAL DO TERRENO	4.600m ²
ÁREA CONSTRUÍDA	3.002,70m ²
ÁREA PERMEÁVEL	1.505,30 m ²
TAXA DE OCUPAÇÃO	65,27%



Trabalho de Conclusão de Curso II
Arquitetura e Urbanismo – UNIS/MG
Aluna: Ana Luiza Venga Ferreira
Orientadora: Daniella Coli

PROJETO ARQUITETÔNICO CENTRO INTERGERACIONAL CONECTA GERAÇÕES NA CIDADE DE VARGINHA/MG

Conteúdo da Prancha:

Fachada Frontal
Perspectiva 1 Perspectiva 2
Perspectiva 3 Perspectiva 4

Escalas Indicadas
Data: 17/06/2019

LEGENDA:

-  Piso Intertravado
-  Piso Concregrama/Pisograma
-  Piso de Pneu Reciclado
-  Piso de Concreto Drenante
-  Grama Esmeralda
-  Deck em madeira



Deck em madeira

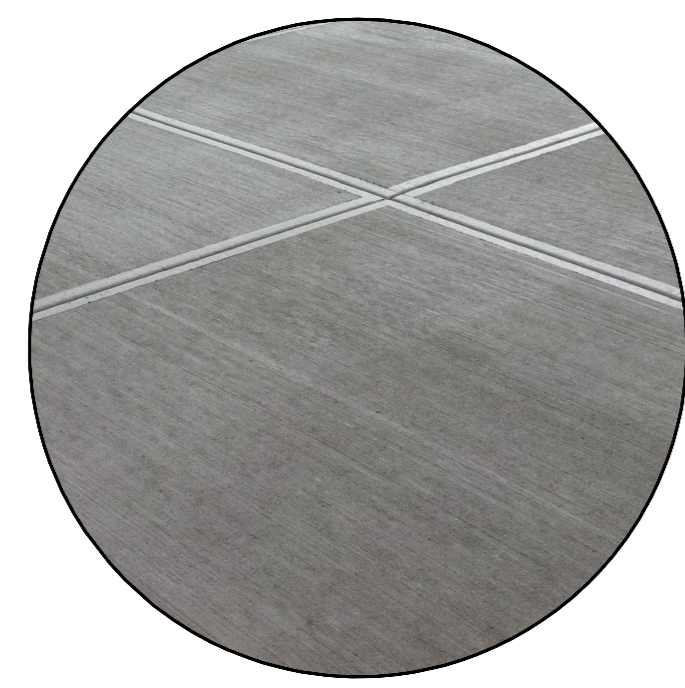

Piso de Concreto Drenante



Piso Concregrama/
Pisograma



Parede Verde

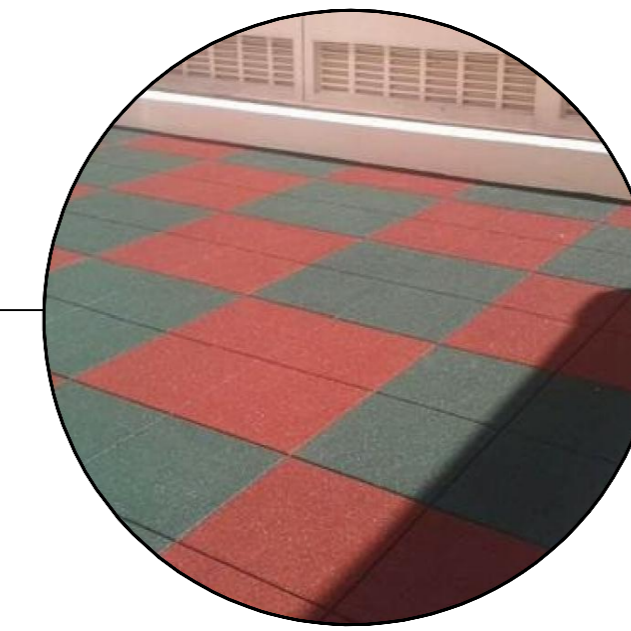

Piso de Pneu Reciclado



Grama Esmeralda



Piso Intertravado



Parede Verde











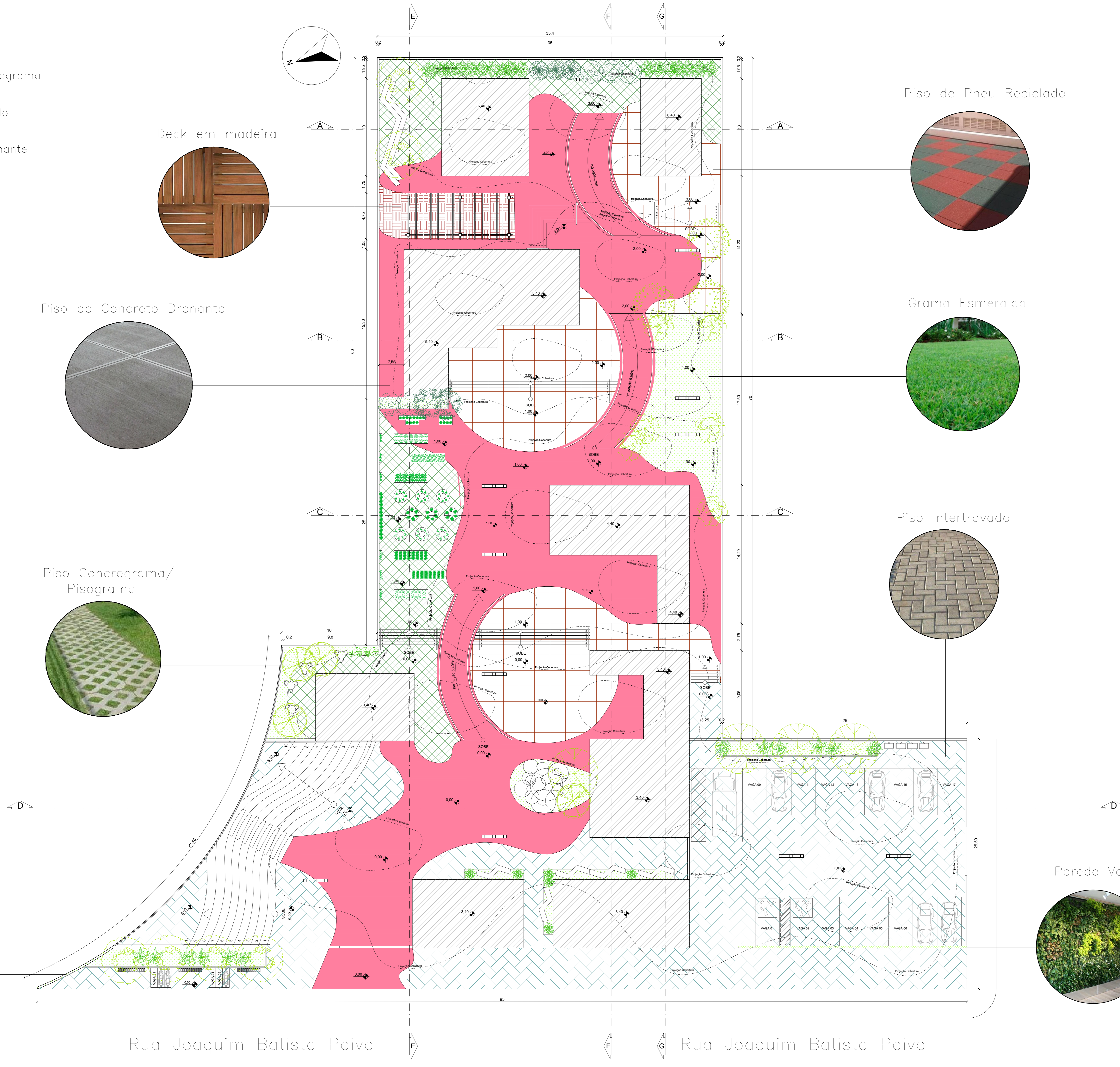

Tabela de Espécies – A. Frutíferas					
Símbolo	Unidades	Nome Popular	Dímetro	Altura	Imagem
	3 Unidades	Urbucoba Híbrida	2 metros	4 metros	
	5 Unidades	Acácia	2,5 metros	5 metros	
	2 Unidades	Romãzeira	3 metros	4,5 metros	
Tabela de Espécies – Árvores					
Símbolo	Unidades	Nome Popular	Dímetro	Altura	Imagem
	6 Unidades	Roseiro-Rosa	3 metros	5 metros	
	6 Unidades	Quaresmeiro de Flor Rosa	5 metros	10 metros	
	3 Unidades	Ipê Amarelo	4,5 metros	8 metros	
	4 Unidades	Pitá-da-Índia	5 metros	9 metros	
	4 Unidades	Afemê	3,5 metros	9 metros	
Tabela de Espécies – Arbustos					
Símbolo	Unidades	Nome Popular	Dímetro	Altura	Imagem
	10 Unidades	Bauhinia	1 metro	5 metros	
	10 Unidades	Fishbone-de-Bufo	0,7 metros	6 metros	
	30 Unidades	Estreito	1 metro	1,8 metros	
Tabela de Espécies – Horta					
Símbolo	Unidades	Nome Popular	Dímetro	Altura	Imagem
	40 mudas	Salsinha	-	-	
	20 mudas	Cebolinha	-	-	
	24 mudas	Horradá	-	-	
	40 mudas	Manjerico	-	-	
	24 mudas	Alcachofra	-	-	
	20 mudas	Couve	-	-	
	20 mudas	Afioce	-	-	
	15 mudas	Tomilho-Carpas	-	-	
	14 mudas	Abacaxina	-	-	
	30 mudas	Espinafre	-	-	

TABELA DE ÁREAS

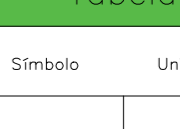
ÁREA TOTAL DO TERRENO	4.600m ²
ÁREA CONSTRUÍDA	3.002,70m ²
ÁREA PERMEÁVEL	1.505,30 m ²
TAXA DE OCUPAÇÃO	65,27%

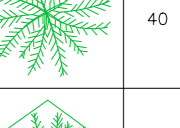

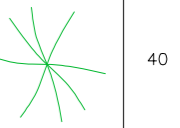
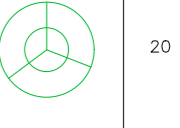
Trabalho de Conclusão de Curso II
Arquitetura e Urbanismo – UNIS/MG
Aluna: Ana Luiza Venga Ferreira
Orientadora: Daniella Coli

PROJETO ARQUITETÔNICO CENTRO INTERGERACIONAL CONECTA GERAÇÕES NA CIDADE DE VARGINHA/MG

Conteúdo da Prancha:
Planta de Paisagismo e Paginação de Piso
Tabela de Espécies

Escalas Indicadas
Data: 17/06/2019